

# 18' x 9' x 52" Elite Rectangular Frame Pool

Model : P4180952B0FR











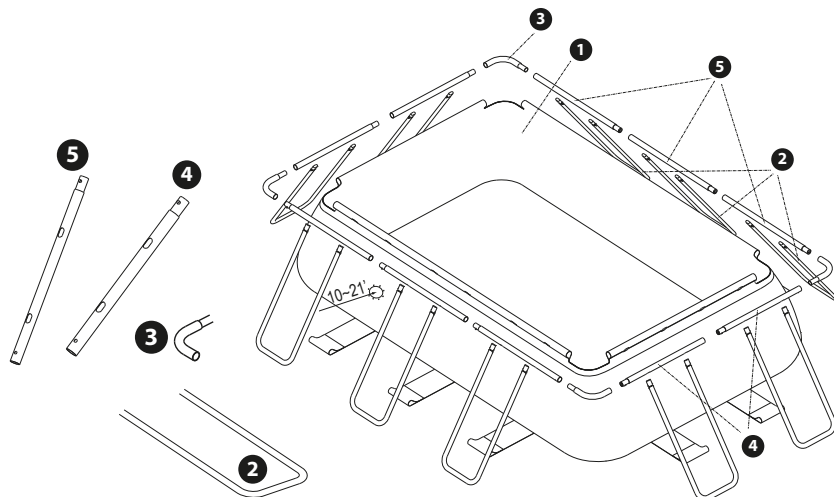

## Specifications

Brand	: Summer Waves®	AGP Type	: Elite Rectangular Frame Pool
Size	: 18' x 9' x 52" (5.49 m x 2.74 m x 1.32 m)	Water Capacity	: 4551 Gallons (17225 L)
Filter Pump	: RX1500 220~240V	Pump Flow Rate	: 1400 Gallons (5299 L)
Filter Cartridge	: A/C Type	Accessories	: SureStep™ Ladder, Pool Cover, Deluxe Maint. Kit, Ground Cloth, Repair Patch
Printing	: Mosaic		
Warranty	: Pool Liner : 90 days Pump : 180 days		

## Part List

### Metal Frame



No#	Spare part	Photo	SAP#	No#	Spare part	Photo	SAP#
1	Pool Liner		P40918525099	4	Short Tube		P5A1B0003E01
	U-Shape Pipe		P5A4B0001E01	5	Long tube		P5A1B0006E01
2	V- shape Pin		P5ANPF088E01	6	O-shapeSpring Pin		P5APF1180E01
	Grey cap		P5ANPF089E01		Drain Plug		P58080173W01
3	comer piece		P5A5A0001E01				

**Pump**

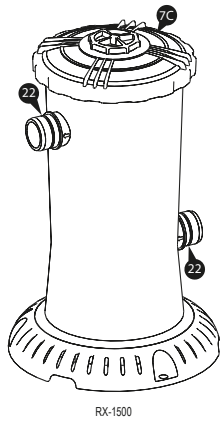

RX-1500

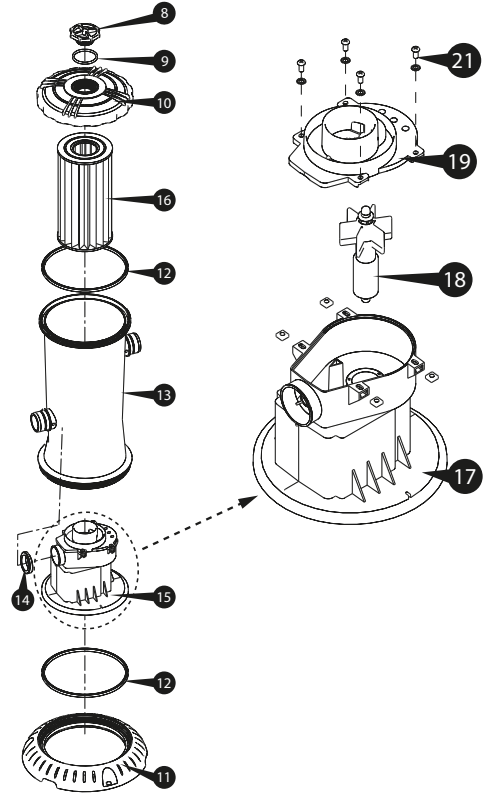
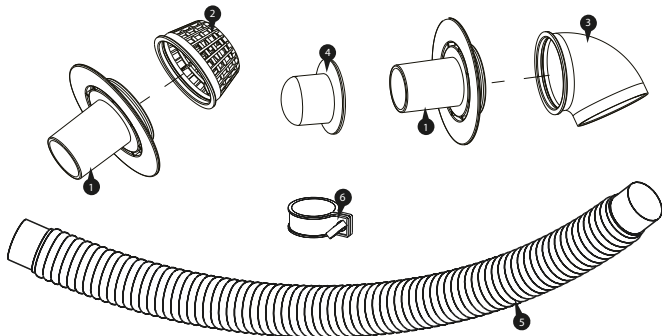

No#	Spare part	Photo	SAP#	No#	Spare part	Photo	SAP#
1	Sunction Fitting Base		P58PF5510P01	12	Canister Gasket		P58164800K01
2	Suction Fitting Screen		P58PF5480P01	13	Filter Pump Gasket		P58PP1840W05
3	Flow Diverter		P58PF5520P01	14	Nozzle		P58185201K01
4	Plug		P58PF5500K01	15/17/21	Motor Assembly		P58X150000GS
5	102" Hose		P584150004W1	16	Type A/C Filter Cartridge		P583041080PR
6	Hose Camp		P58219221W05	18	Rotor Assembly		P58050506001
8	Vent Screw		P58182201W05	19	Volute Cover		P58184501K01
9	Vent Screw O-Ring		P58182501K01	22	Filter Pump Port/ Fitting O-Ring		P58037000K01
10	Seal Top		P58PP1853W05		Wrench		P5810250000E
11	Base		P58183901W05				

**Ladder**

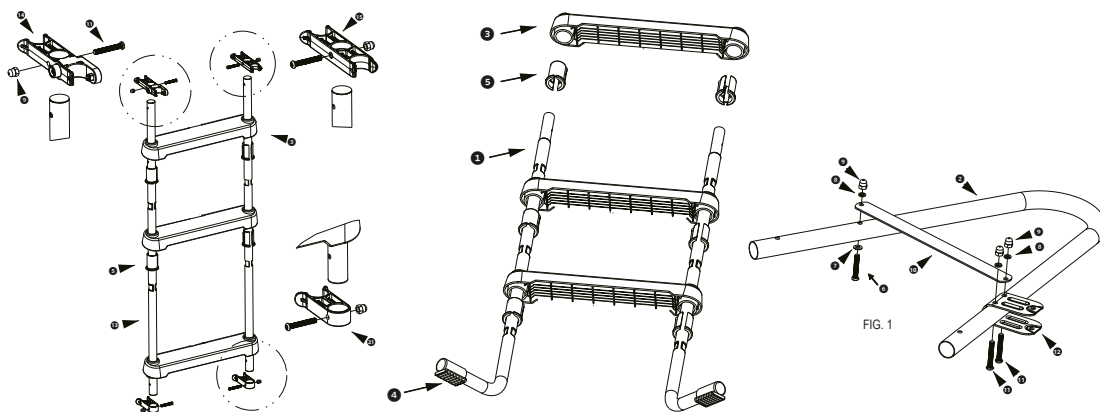

No#	Spare part	Photo	SAP#	No#	Spare part	Photo	SAP#
1	Ladder Legs		P5901515270E	6	Machine Screw A (L=35mm)		P59060350299
2	Ladder Handles		P5911011200E	7	Flat Washer (metal)		
3	Ladder Steps		P59PF5660W05	16	Hex Nut		P59060450199
4	Led End Caps		P59PF0090W05	8	Lock Washers		
5	Ladder Step Clips		P59PF0070W05	9	Cap Nut		
10	Ladder Brace with Warning		P5942003661E	18	Machine Screw C (L=45mm)		P59060450199
12	Ladder Hinge		P5992001753E	20	Plastic Flat Washer		
13	Straight Ladder Leg		P5961513300E	6	Machine Screw A (L=35mm)		P59060350099
14	Swivel Ladder Clamp with Button		P59446447W05	7	Flat Washer (metal)		
15	Swivel Ladder Clamp		P59PF4460W05	8	Lock Washers		
17	Ladder Base Plate		P59A2005204E	9	Cap Nut		P59060400099
19	Plain Ladder Leg		P5911515270E	11	Machine Screw (L=40mm)		
21	Ladder Bottom Clip		P59PF4500W05	8	Lock Washers		
				9	Cap Nut		

**Accessories**

**Cover**











Spare part	Photo	SAP#
Cover		P521600F0099

**Ground Cloth**

Spare part	Photo	SAP#
Grand Cloth		P51160000099



### Maintanance Kit

No#	Spare part	Photo	SAP#	No#	Spare part	Photo	SAP#
1	Telescopic Pole		P5BB7000000P	6	Hose Clip		P5651001A099
2	Leaf Net-1Piece		P5651001A099	7	Hose clamp		P58219221W05
3	Vacuum Head		P56000010099	8	Vacuum Adapter		P58PP1955W05
4	Hose		P564125004W1	9	Gasket		P56000010099
5	Vacuum Bag		P56000010099	10	V Shaped spring clips		P5651001A099